

Current part is item (4) on diagram. Available at www.oshkoshequipment.com

(1) FIG. NO.	(2) ITEM NO.	(3) SMR CODE	(4) NATIONAL STOCK NUMBER	(5) PART NUMBER	(6) FSCM	(7) DESCRIPTION U/M	(8) INC IN UNIT
2004 - POWER TAKE-OFF ASSEMBLY							
316	1	PAOZZ	5315-00-839-5822	MS24665-353	96906	PIN,COTTER AE	EA 1
316	2	XBOZZ	5315-00-140-1938	MS35810-36	96906	PIN AE	EA 1
316	3	PAOOO	2520-00-706-1230	7061230	19207	ROD,SHIFTING LEVER: CONTROL,SHIFTING LEVER: W/YOKE,TRANSMISSION PTO AE	EA 1
316	4	PAOZZ	2520-00-337-8223	7372751	YOKE,DECLU	LEVER ROD,TRANSMISSION PTO AE	EA 1
316	5	PAOZZ	5310-00-732-0560	MS51968-14	96906	NUT,PLAIN,HEXAGON AE	EA 1
316	6	PAOZZ	5340-00-211-5406	7061231	19207	CLEVIS AE	EA 1
316	7	PAOZZ	5310-00-067-9507	MS51922-37	96906	NUT,SELF-LOCKING AE	EA 1
316	8	PAOZZ	5305-00-226-7768	MS90726-115	96906	SCREW,CAP,HEXAGON HEAD AE	EA 1
316	9	PAOZZ	2520-00-706-1229	7061229	19207	LEVER,SHIFTING: HAND, TRANSMISSION PTO AE	EA 1
316	10	XBOZZ		7373223	19207	BOLT,MACHINE: HAND LEVER SUPPORT TO BRAKE MASTER CYLINDER,TRANSMISSION PTO AE	EA 2
316	11	PAOZZ	2520-00-622-3927	7529104	19207	SUPPORT,SHIFTING LEVER AE	EA 1
316	12	PAOZZ	5310-00-959-7600	MS51922-5	96906	NUT,SELF-LOCKING AE	EA 2
316	13	PAOZZ	5305-00-068-0504	MS90726-3	96906	SCREW,CAP,HEXAGON HEAAD AE	EA 2
316	14	PAOZZ	2520-00-753-8790	7538790	19207	LOCK: SHIFTING LEVER, TRANSMISSION PTO AE	EA 1
316	15	PAOZZ	5305-00-855-0961	MS24629-35	96906	SCREW,TAPPING,THREAD AE	EA 2
316	16	PAOZZ	9905-00-753-8792	7538792	19207	PLATE,INSTRUCTION AEA	EA 1
317	1	PAFZZ	5310-00-732-0559	MS51968-8	96906	NUT,PLAIN,HEXAGON	EA 6
317	2	PAFZZ	5310-00-637-9541	MS35338-46	96906	WASHER,LOCK	EA 6
317	3	PAFZZ	5307-00-753-8668	7538668	19207	STUD,PLAIN	EA 6
317	4	PAFHH	2520-00-229-5673	11609228	19207	POWER TAKE-OFF (TRANS) (SEE TM 9-2520-246-34P)	EA 1
317	5	PAFHH	2520-00-706-1137	7061137	19207	POWER TAKE-OFF: FRONT OUTPUT SHAFT ONLY,TRANSMISSION (USED ON VEHICLE AFTER SERIAL NO. 95238 (SEE TM 9-2520-246-34P)	EA 1
317	5	PAFHH	2520-00-706-1136	7061136	19207	POWER TAKE-OFF: FRONT AND REAR OUTPUT SHAFTS,TRANSMISSION (SEE TM 9-2520-846-34P)	EA 1
318	1	PAOZZ	5305-00-569-8909	7372083	19207	SCREW,WITH LOCK: PTO ROD END (M292A5)	EA 1

Current part is item (4) on diagram. Available at www.oshkoshequipment.com

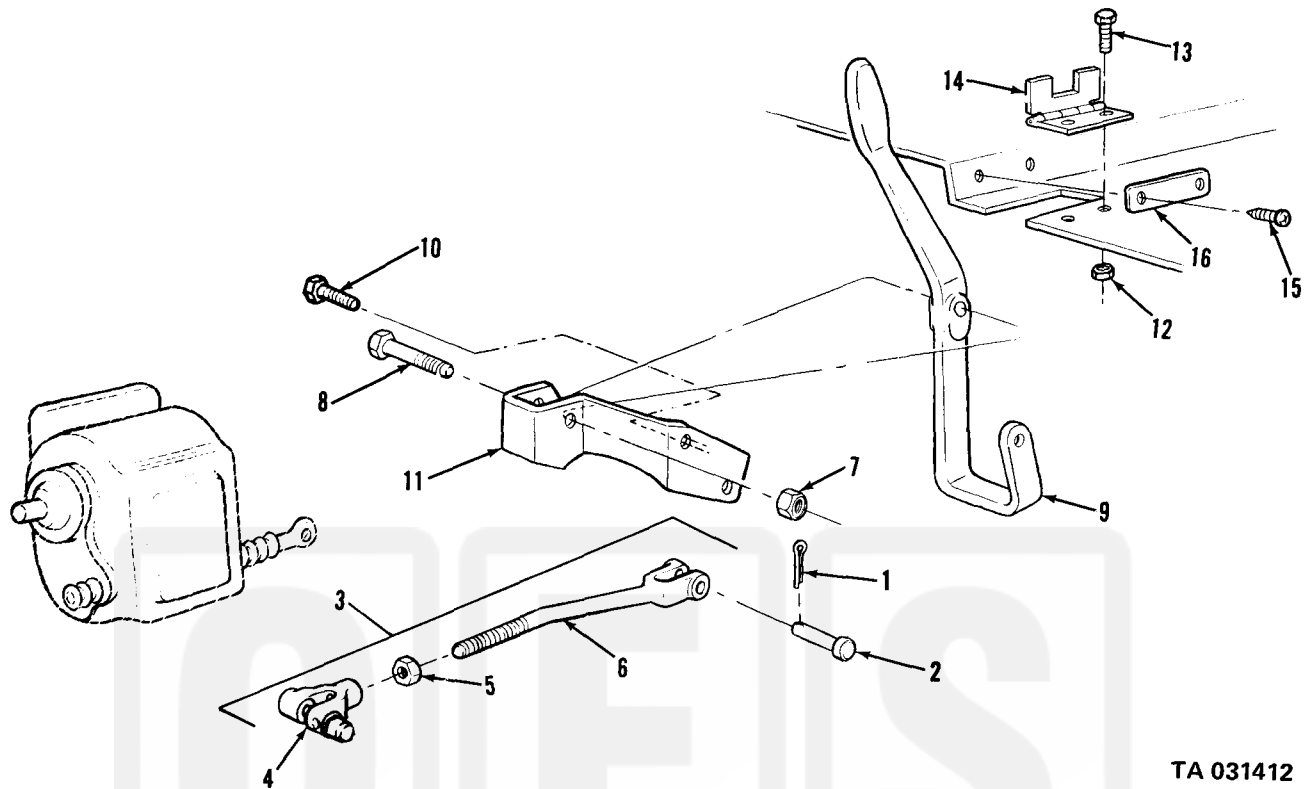

Figure 316. Power take-off controls-transmission.

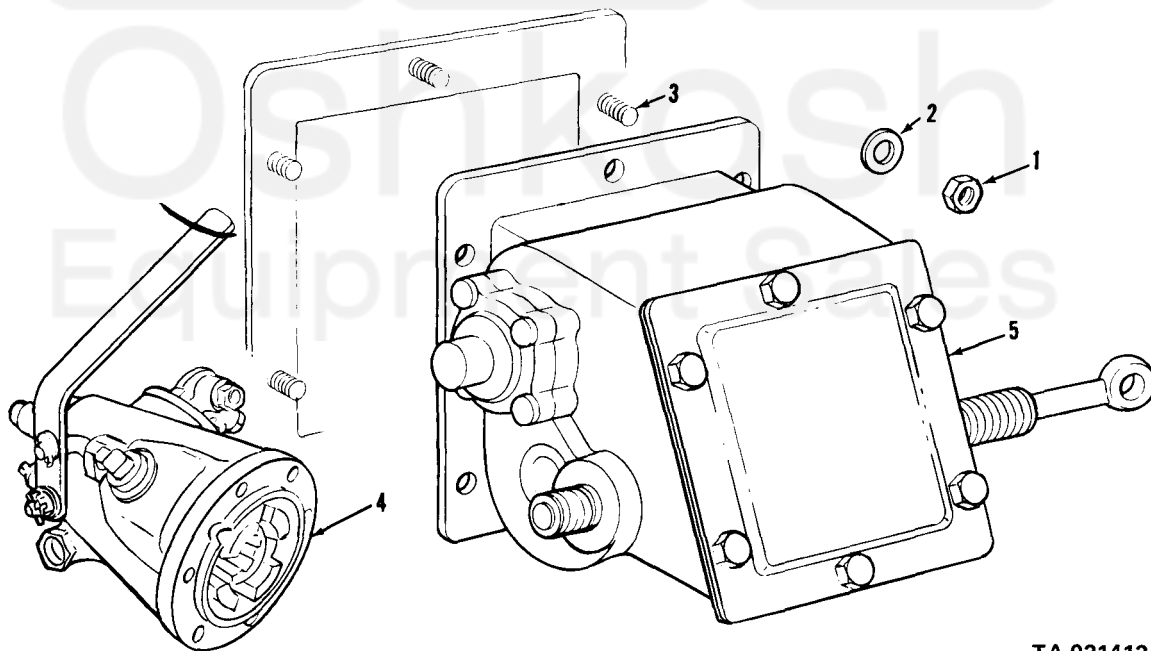

Figure 317. Power take-off assembly.

Current part is item (4) on diagram. Available at www.oshkoshequipment.com